

# Cookbook

DELI AND GRAB-AND-GO



**PRÁTICA**  
HIGH SPEED OVENS

---

# Prática's High-Speed Ovens

Elevating deli and grab-and-go experiences

- **Lightning-fast cooking times, ensuring quick service for busy deli and grab-and-go establishments**
- **Streamlined operations, capable of handling high volumes without compromising quality**
- **Versatility to cook a wide range of delectable items, from sandwiches to pastries and more**
- **Precise temperature and humidity control for consistent and mouthwatering results**
- **Advanced safety features, ensuring a secure cooking environment**
- **Energy-efficient design, minimizing costs, and supporting sustainability initiatives**

**Expand your menu, maximize your profits, and minimize your operational costs.**





Experience the game-changing capabilities of Prática's ventless smart high-speed ovens for deli and grab-and-go establishments! We understand the need for fast and flavorful options that cater to customers on the go. Our ovens are the perfect solution, revolutionizing the way you prepare and serve your menu offerings.



Operating our high-speed ovens is simple and efficient. Once your customized settings and recipes are established, it's a breeze to deliver delicious food items in a fraction of the time. The user-friendly interface allows for an easy selection of recipes, ensuring consistent quality and outstanding flavors with every order.



With our support, you can unleash your culinary creativity and deliver unforgettable flavors that keep customers coming back for more.



This cookbook has been curated with recipes tailored specifically for our high-speed ovens, considering the atmosphere of delis and grab-and-go establishments. It serves as a valuable starting point by offering you settings based on the recipes tested in our kitchen.

You have the flexibility to customize cooking parameters according to your preferences, empowering you to achieve the perfect textures and flavors envisioned for your business.

These recipes are not only examples but also sources of inspiration. Feel free to create additional recipes with different flavors and variations, aligning them with your deli and grab-and-go establishment's unique menu.

On each page, you will find:

- A picture illustrating the featured food item
- The precise settings used for preparing that food item on each recommended high-speed oven
- A direct link to the recipe page on our website, providing more details and authentic pictures of the results achieved in our test kitchen
- An additional link to a short video showcasing the high-speed oven in action, specifically demonstrating that particular recipe.

Our expert team is available to assist you in ongoing support, troubleshooting, and recipe refinement.



# INDEX

## FOOD

- 6 Panini
- 7 Chicken breast
- 8 Chicken Wings
- 9 French Fries
- 10 Tater tots
- 11 Sandwiches
- 12 Keeping salad cold while heating the meat
- 13 Burritos
- 14 Pizza by the slice
- 15 Flatbreads

## HIGH SPEED OVENS

- 16 Fit Express
  - 18 Fit SM
  - 20 Fit XL
  - 22 Fit ST
  - 24 Forza STI
  - 26 Rocket Express
- 
- 28 IOK - Internet of Kitchen
  - 30 Cleaning products/Accessories
  - 34 Company
  - 38 Price list and warranty





# Panini





Serve up a delicious toasted panini in no time. The savory fillings, perfectly nestled between toasted bread, create a satisfying and convenient dining experience for your customers. Say goodbye to long waits and hello to quick and tasty paninis.

[LEARN MORE](#)





[WATCH THE VIDEO](#)

Settings for toasting a ham and cheese panini:

**FIT EXPRESS**

1°	90% 
 0:40sec	40% 
	500°F 

**ROCKET EXPRESS**

1°	90% 
 0:40sec	40% 
	100% 
	500°F 

[BACK TO MENU](#)



# Chicken breast





Refrigerate and reheat pre-cooked chicken breast to minimize waste in delis and grab-and-go restaurants. Our high-speed ovens efficiently warm the chicken to perfection, preserving its juicy and tender texture. Deliver flavorful and convenient chicken dishes that maintain their quality and taste.

[LEARN MORE](#)





[WATCH THE VIDEO](#)

Settings for reheating 2 pre-cooked chicken breasts:

## FIT EXPRESS

1°	90% 
 0:50sec	40% 
	500°F 

## ROCKET EXPRESS

1°	90% 
 0:50sec	40% 
	70% 
	500°F 

BACK TO MENU 



# Chicken Wings

Our high-speed ovens transform 10 frozen wings into delicious, mouthwatering, ready-to-eat perfection in just 3:30 min. Say goodbye to long waits and hello to crispy, tender, flavor-packed wings that will have your customers coming back for more. And the best part? No oil is needed, making it a healthier option for everyone to enjoy.

[LEARN MORE](#)

[WATCH THE VIDEO](#)

Settings for baking 8 pre-cooked chicken wings:

## FIT EXPRESS

1°	100%	🔥
🕒	60%	🔥
2min15sec	525°F	🔥

2°	100%	🔥
🕒	30%	🔥
30sec	525°F	🔥

## ROCKET EXPRESS

1°	100%	🔥
🕒	60%	🔥
2min15sec	100%	🔥
	525°F	🔥

2°	100%	🔥
🕒	30%	🔥
30sec	100%	🔥
	525°F	🔥

BACK TO MENU





# French Fries

With our ventless high-speed ovens, frozen French fries become crispy and golden in no time. They're perfectly cooked on the outside and tender on the inside. No need for a large kitchen or complex ventilation systems. Plus, no extra oil is needed, making it a healthier choice for all.

[LEARN MORE](#)

[WATCH THE VIDEO](#)

## Settings for baking frozen french fries:

### FIT EXPRESS

1°	70%
2min45sec	40% 500°F

2°	70%
1min10sec	10% 500°F

### ROCKET EXPRESS

1°	70%
2min45sec	40% 100% 500°F

2°	70%
1min10sec	10% 100% 500°F

BACK TO MENU







# Tater tots





Each tot is cooked to perfection, with a crispy exterior and a fluffy interior. Our ovens ensure quick and consistent results, making them the perfect choice for tater tot lovers everywhere.

Settings for baking frozen tater tots:

## FIT EXPRESS

1°	100% 
 1min35sec	70% 
	500°F 

## ROCKET EXPRESS

1°	100% 
 1min35sec	70% 
	100%  500°F 

[LEARN MORE](#)

[WATCH THE VIDEO](#)

[BACK TO MENU](#)



# Sandwiches

Whether it's a classic grilled cheese, an Italian sub, or a savory steak sandwich, our high-speed ovens ensure outstanding results. With precise heating, the cheese melts to perfection, the fillings are warmed to enhance their flavors, and the bread is toasted to a delightful crunch.

[LEARN MORE](#)

[WATCH THE VIDEO](#)

Settings for a refrigerated 12" sub sandwich:

## FIT EXPRESS

1°	80%
0:40sec	40%
	500°F

## ROCKET EXPRESS

1°	80%
0:40sec	40%
	60%
	500°F

BACK TO MENU



## Keeping salad cold while heating the meat

If you prefer keeping your sandwiches fully assembled and refrigerated, including the salad, instead of adding it after toasting, our high-speed ovens make it possible. With precise temperature control, the meat is heated perfectly, while the salad stays chilled and crisp. The sandwiches should be assembled in the correct order. For assistance in programming this recipe, please contact our team.

[LEARN MORE](#)

[WATCH THE VIDEO](#)

Settings for toasting a 12" salad sub sandwich:

**FIT EXPRESS**

1°	100%
0:35sec	50%  500°F

**ROCKET EXPRESS**

1°	100%
0:35sec	50%  100%  500°F

[BACK TO MENU](#)



# Burritos

The tortillas are warmed and maintained at a soft texture, while the fillings are heated to a satisfying temperature. With their efficient cooking times, our ventless smart high-speed ovens can handle continuous operations, ensuring a steady supply of flavorful burritos for your hungry customers.

## Settings for 2 breakfast burritos:

### FIT EXPRESS

1°	0%
0:30sec	70%  500°F

2°	10%
0:30sec	70%  500°F

### ROCKET EXPRESS

1°	0%
0:30sec	70%  100%  500°F

2°	10%
0:30sec	40%  500°F

LEARN MORE

WATCH THE VIDEO

BACK TO MENU



## Pizza by the slice

Reheat a single pizza slice in just 15 seconds or even bake a single slice from frozen dough to perfection in only 50 seconds. Our high-speed ovens are incredibly versatile, and customizable, allowing you to meet various preferences and needs. Each pizza slice served will be a delicious delight, leaving your students craving more.

[LEARN MORE](#)

[WATCH THE VIDEO](#)

Settings for baking a frozen slice:

**FIT EXPRESS**

1°	100%
0:50sec	30%  536°F

**ROCKET EXPRESS**

1°	100%
0:50sec	30%  100%  536°F

BACK TO MENU

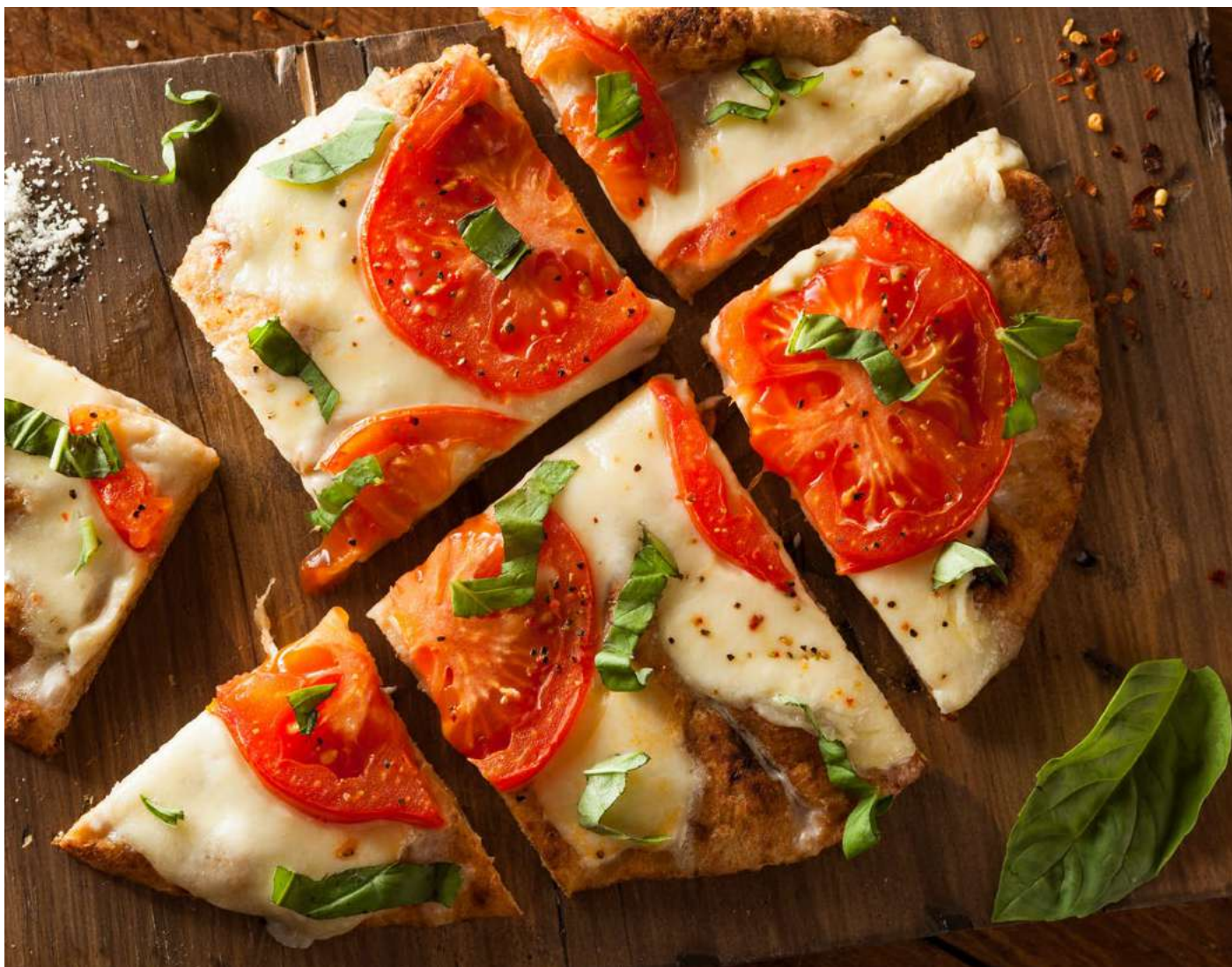

# Flatbreads

The thin and crispy crust is toasted to golden-brown perfection, while the toppings are heated just right. Whether you prefer traditional or innovative combinations, our ovens deliver consistent and delicious results.

Settings for baking a frozen flatbread focaccia style (unthaw first):

## FIT EXPRESS

1°	70%
1min40sec	30%  536°F

## ROCKET EXPRESS

1°	70%
1min40sec	30%  100%  536°F

[LEARN MORE](#)

[WATCH THE VIDEO](#)

[BACK TO MENU](#)



# FIT EXPRESS

The Fit Express high-speed oven is designed for efficiently finalizing refrigerated, fresh, or frozen foods, such as breakfast sandwiches, chicken wings, muffins, lasagnas, mac & cheese, sub sandwiches, and other partially prepared dishes. It delivers excellent flavor, appearance, and crispiness. The combination of impinged air and microwaves allows for heating, browning, or toasting foods faster than traditional methods.



**FIT EXPRESS BLACK**  
SKU: 990136



**FIT EXPRESS ORANGE**  
SKU: 990145

**FIT EXPRESS ORANGE**



- Fits on 15.2" width countertops and cooks 12" pizzas.
- User interface: full-color user-friendly touchscreen display. Drag and drop features.
- iOK: Create, edit, and organize groups, recipes, and complete menus directly on the oven or from your computer using Wi-Fi or USB Flash Drive and send them to all connected ovens.
- Multi-language system: Portuguese, English, Spanish, French, German, Polish, Russian, Mandarin, Greek.
- Ventless: no hoods needed.
- The removable catalytic converter allows operators to perform the cleaning without the need for a maintenance service call.
- Secures consistent results: through precise control, even heat distribution, rapid cooking, built-in sensors, and customization options, ensuring uniform and efficient cooking for reliable outcomes.
- Independently adjust microwave power, temperature, and impinged air while programming recipes on the oven.
- No side vents, allowing zero side clearance.
- Elegant & Intuitive: Stores unlimited recipes, with their own steps, settings, icons, or photos.
- Temperatures up to 536°F: The impinged air convection technology combined with microwave capabilities enables users to cook food faster than when using traditional processes.
- Heat insulation: prevents the surrounding area from heating up and keeps the surface cool to the touch.

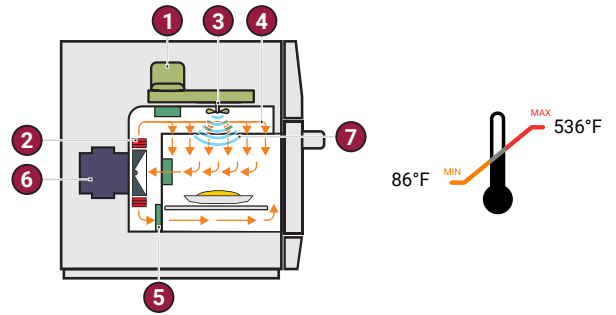

- 1. Magnetron
- 2. Resistance (infrared)
- 3. Stirrer
- 4. Impinged Air
- 5. Catalytic Converter
- 6. Blower Motor
- 7. Microwaves

### COOK TIMES

Chicken Wings Bone-In	<b>3 min 30 sec</b>
Ham & Cheese Panini	<b>55 sec</b>
Mozzarella Sticks	<b>1 min 45 sec</b>
Italian Sub	<b>55 sec</b>
Breakfast Biscuit	<b>1 min 30 sec</b>



LEARN MORE



WATCH THE VIDEO



CAD AND REVIT FILES

### STANDARD ACCESSORIES

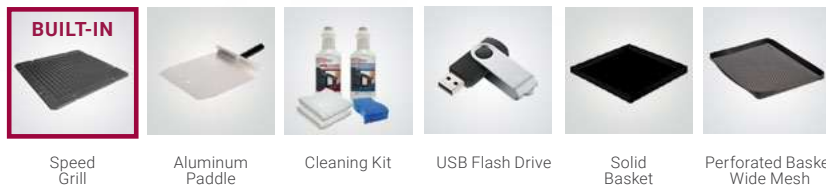

• **1 year warranty** for parts and labor, with the exception of naturally worn items.

FIT EXPRESS DOUBLE MAG											
Region	Voltage (V)	Phases	Freq. (Hz)	Power (kW)	Circuit Breaker (A)	Cable	Socket	Product dimensions (Height x Width x Depth)	Boxed product dimensions (Height x Width x Depth)	Chamber dimensions (Height x Width x Depth)	Clearance (Left / back / right side)
USA / Canada	208 240	Single	60	6.2 7.0	30	3x10 AWG	 NEMA 6-30	25.9 x 15.2 x 27.3 (") <b>147.7 lbs.</b>	35.8 x 20.1 x 35.3 (") <b>200 lbs.</b>	5.2 x 12.4 x 12.1 (") <b>0.45 cu.ft</b>	0" / 0" / 0"



# FIT SM

S I N G L E M A G

The Fit Express Single Mag high-speed oven is designed for efficiently finalizing refrigerated, or fresh food items, such as breakfast sandwiches, pizzas, sub sandwiches, pastries and more! It delivers excellent flavor, appearance, and crispiness. The combination of impinged air and microwaves allows for heating, browning, or toasting foods faster than traditional methods. The Fit Express SM is not recommended for frozen food.



**FIT SM SILVER**  
SKU: 990170

- Ideal for fresh or refrigerated food items. Not recommended for frozen food.
- Energy efficient: It is designed to be energy-efficient, so you save money on electricity comparing to other models.
- Fits on 15.2" width countertops and cooks 12" pizzas and sandwiches.
- User interface: full-color user-friendly touchscreen display. Drag and drop features.
- IOK: Create, edit, and organize groups, recipes, and complete menus directly on the oven or from your computer using Wi-Fi or USB Flash Drive and send them to all connected ovens.
- Ventless: no hoods needed.
- The removable catalytic converter allows operators to perform the cleaning without the need for a maintenance service call.
- Independently adjust microwave power, temperature, and impinged air while programming recipes on the oven.
- No side vents, allowing zero side clearance.
- Elegant & Intuitive: Stores unlimited recipes, with their own steps, settings, icons, or photos.
- Temperatures up to 536°F: The impinged air convection technology combined with microwave capabilities enables users to cook food faster than when using traditional processes.
- Heat insulation: prevents the surrounding area from heating up and keeps the surface cool to the touch.

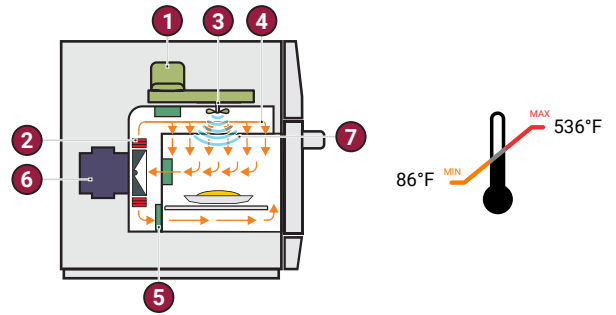

- 1. Magnetron
- 2. Resistance (infrared)
- 3. Stirrer
- 4. Impinged Air
- 5. Catalytic Converter
- 6. Blower Motor
- 7. Microwaves

### COOK TIMES

Pastries	25 sec
Sub Sandwiches	40 sec
Breakfast Sandwiches	2 min
Paninis	1 min 10 sec



LEARN MORE



CAD AND REVIT FILES

### STANDARD ACCESSORIES



• 1 year warranty for parts and labor, with the exception of naturally worn items.

FIT EXPRESS SINGLE MAG											
Region	Voltage (V)	Phases	Freq. (Hz)	Power (kW)	Circuit Breaker (A)	Cable	Socket	Product dimensions (Height x Width x Depth)	Boxed product dimensions (Height x Width x Depth)	Chamber dimensions (Height x Width x Depth)	Clearance (Left / back / right side)
USA / Canada	208 240	Single	60	2.7 3.1	15	3x10 AWG	 NEMA 6-15	24.4 x 15.2 x 27.3 (") 123.4 lbs.	35.8 x 20.1 x 35.3 (") 175.7 lbs.	5.2 x 12.4 x 12.1 (") 0.45 cu.ft	0" / 0" / 0"



# FIT XL

The Fit XL high-speed oven features a 16-inch chamber and is designed to efficiently finalize refrigerated, fresh, or frozen foods, such as breakfast sandwiches, chicken wings, muffins, lasagnas, mac & cheese, sub sandwiches, and other partially prepared dishes. Capable of handling larger portions, it is ideal for medium and large businesses. The FIT XL delivers excellent flavor, appearance, and crispiness. By combining impinged air and microwaves, it heats, browns, and toasts foods faster than traditional methods.



**FIT XL BLACK**  
SKU: 990200



**FIT XL SILVER**  
SKU: 990179



- 16-inch chamber.
- Capable of handling larger portions, it is ideal for medium and large businesses.
- Stores unlimited recipes with up to 8 steps each, divided into 16 groups.
- USB port for system updates and importing/exporting groups, recipes, and settings.
- Wi-Fi capabilities, enabling remote management for system updates and importing/exporting groups, recipes, and settings via the IOK online platform.
- Adjustable temperature from 86°F (30°C) to 536°F (280°C).
- Independent control of impinged air (high-speed air blast) and microwaves.
- User-friendly touchscreen panel.
- Constructed from stainless steel.
- Certified Ventless – no need for vent hoods. Easy-to-remove catalytic converter for hassle-free cleaning.
- Additional functionalities: Test Mode and Favorites.
- Daily cleaning guide with explanatory videos displayed on the screen, demonstrating the step-by-step process.
- Warranty: one (1) year covering manufacturer defects, part failures, and pre-approved labor, and two (2) years on all the heating elements, magnetrons, and blower motor of the oven.

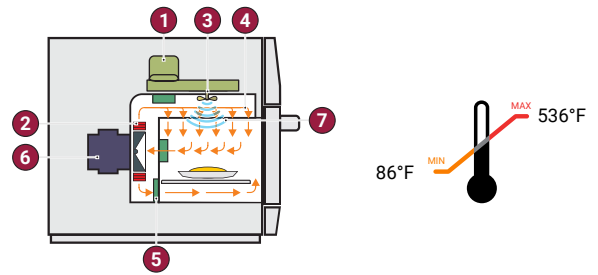

1. Magnetron
2. Resistance (infrared)
3. Stirrer
4. Impinged Air
5. Catalytic Converter
6. Blower Motor
7. Microwaves

### COOK TIMES

16" Frozen Pizza	<b>3 min 30 sec</b>
3 Sub Sandwiches 16"	<b>50 sec</b>
6 Paninis	<b>1 min 30 sec</b>
5.5 lb Frozen Chicken Wings	<b>5 min</b>
2 lb Frozen Fries	<b>4 min 30 sec</b>



CERTIFIED  
**VENTLESS**  
WITH EASILY REMOVABLE  
CATALYTIC CONVERTER.



LEARN MORE



WATCH THE VIDEO



CAD AND REVIT FILES

### STANDARD ACCESSORIES



Region	Voltage (V)	Phases	Freq. (Hz)	Power (kW)	Circuit Breaker (A)	Cable	Socket	Product dimensions (Height x Width x Depth)	Boxed product dimensions (Height x Width x Depth)	Chamber dimensions (Height x Width x Depth)	Clearance (Left / back / right side)
USA / Canada	208 240	Single	60	6.2 7.0	30	3x10 AWG		25.9 x 19.2 x 31.3 (") <b>180.8 lbs.</b>	35.6 x 23.2 x 37.8 (") <b>227 lbs</b>	5.5 x 16.4 x 16.1 (") <b>0.83 cu.ft</b>	0" / 0" / 0"



# FITST

The Fit ST high-speed oven features a 12-inch chamber and can be stacked up to two units high. It is designed to efficiently finalize refrigerated, fresh, or frozen foods, such as breakfast sandwiches, chicken wings, muffins, lasagnas, mac & cheese, sub sandwiches, and other partially prepared dishes. Ideal for any business size, the oven delivers excellent flavor, appearance, and crispiness. By combining impinged air and microwaves, it heats, browns, and toasts foods faster than traditional methods.



## STACKABLE



**Fit ST Black**  
SKU: 990188

**Fit ST Black Double Stacked:**  
SKU: 990188-DBL

**Fit ST Silver:**  
SKU: 990163

**Fit ST Silver Double Stacked:**  
SKU: 990163-DBL



- The FIT ST can be stacked up to 2 units (1+1).
- Stores unlimited recipes with up to 8 steps each, divided into 16 groups.
- USB port for system updates and importing/exporting groups, recipes, and settings.
- Wi-Fi capabilities, enabling remote management for system updates and importing/exporting groups, recipes, and settings via the IOK online platform.
- Adjustable temperature from 86°F (30°C) to 536°F (280°C).
- Independent control of impinged air (high-speed air blast) and microwaves.
- User-friendly touchscreen panel.
- Constructed from stainless steel.
- Certified Ventless – no need for vent hoods. Easy-to-remove catalytic converter for hassle-free cleaning.
- Additional functionalities: Test Mode and Favorites.
- Daily cleaning guide with explanatory videos displayed on the screen, demonstrating the step-by-step process.
- Warranty: one (1) year covering manufacturer defects, part failures, and pre-approved labor, and two (2) years on all the heating elements, magnetrons, and blower motor of the oven.

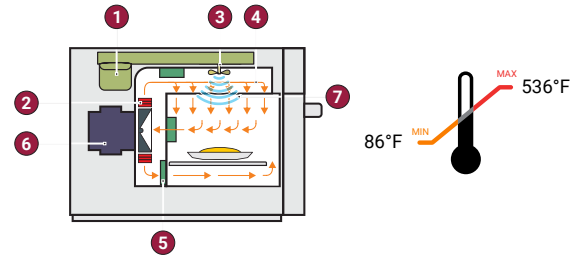

- 1. Magnetron
- 2. Resistance (infrared)
- 3. Stirrer
- 4. Impinged Air
- 5. Catalytic Converter
- 6. Blower Motor
- 7. Microwaves

### COOK TIMES

Burrito	1 min
8 OZ Frozen Chicken Wings	3 min 30 sec
Ham & Cheese Panini	1 min 15 sec
3 Corn Dogs	1 min 30 sec
Tater Tots	3 min

CERTIFIED  
**VENTLESS**  
WITH EASILY REMOVABLE  
CATALYTIC CONVERTER.



LEARN MORE



WATCH THE VIDEO



CAD AND REVIT FILES

### STANDARD ACCESSORIES



Region	Voltage (V)	Phases	Freq. (Hz)	Power (kW)	Circuit Breaker (A)	Cable	Socket	Product dimensions (Height x Width x Depth)	Boxed product dimensions (Height x Width x Depth)	Chamber dimensions (Height x Width x Depth)	Clearance (Left / back / right side)
USA / Canada	208 240	Single	60	6.2 7.0	30	3x10 AWG		16.7 x 20.4 x 27.4 (") 158.7 lbs.	28.4 x 24.4 x 32.5 (") 207.2 lbs.	5.2 x 12.4 x 12.1 (") 0.45 cu.ft	0" / 0" / 1"



# FORZA STi

Designed to ensure swift and exceptional deliveries, even during peak demands, the Forza Sti proves to be an ideal solution for QSR (Quick Service Restaurants) establishments, as well as pizzerias, bakeries, hotels, kiosks, and convenience stores. The production of pizzas, flatbreads, cookies, and more becomes even better with the Forza STi, ensuring superior appearance, flavor, and textures. The combination of impinged air and infrared radiation allows for heating, browning, or toasting foods faster than traditional methods.



## STACKABLE



**Forza STi**  
SKU: 990115



**Forza STi Double Stacked**  
SKU: 990115-DBL



- Secures consistent results: through precise control, even heat distribution, rapid cooking, built-in sensors, and customization options, ensuring uniform and efficient cooking for reliable outcomes.
- Pizzas up to 16": fresh, or par-baked dough, thin or thick crust.
- Stackable: can be stacked up to two ovens.
- Each cavity has its own independent controls, allowing the temperature to be set individually, up to 626°F each.
- Elegant & Intuitive: stores unlimited recipes, with their own steps, settings, icons, or photos.
- User interface: full-color user-friendly touchscreen display. Drag and drop features.
- Multi-language system: Portuguese, English, Spanish, French, German, Polish, Russian, Mandarin, Greek.
- IOK: Create, edit, and organize groups, recipes, and complete menus directly on the oven or from your computer using Wi-Fi or USB Flash Drive and send them to all connected ovens.
- Ventless: no hoods needed.
- The removable catalytic converter allows operators to perform the cleaning without the need for a maintenance service call.
- Heat insulation: prevents the surrounding area from heating up and keeps the surface cool to the touch.

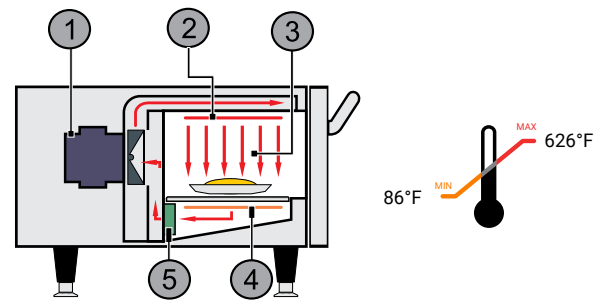

1. Blower Motor
2. Impingement Heater
3. Impinged Air
4. IR heater
5. Catalytic Converter

### COOK TIMES

Bruschettas	45 sec
Toasted Sub Sandwich	55 sec
Fresh Dough 16" Pizza	3 min 30 sec
Half size sheet pan of cookies	10 min
Flatbread Pizza	2 min 15 sec

CERTIFIED  
**VENTLESS**  
WITH EASILY REMOVABLE  
CATALYTIC CONVERTER.



⊕ OPTIONAL ADJUSTABLE FEET



LEARN MORE



WATCH THE VIDEO



CAD AND REVIT FILES

### STANDARD ACCESSORIES



Aluminum Paddle

Cleaning Tool

Pizza Screen



Cleaning Kit

Air Inlet Filter

USB Flash Drive

✓ • 1 year warranty for parts and labor, with the exception of naturally worn items.

Region	Voltage (V)	Phases	Freq. (Hz)	Power (kW)	Circuit Breaker (A)	Cable	Socket	Product dimensions (Height x Width x Depth)	Boxed product dimensions (Height x Width x Depth)	Chamber dimensions (Height x Width x Depth)	Clearance (Left / back / right side)
USA / Canada	208	Single	60	5.6	30	3x10 AWG		Without feet 13.4 x 27.7 x 31 (") 148 lbs.	25.2 x 33.2 x 37.6 (") 209.4 lbs.	3.6 x 18.1 x 17.1 (") 0.65 cu.ft	0" / 0" / 1"
	240			With feet 17.4 x 27.7 x 31 (") 148 lbs.							



# ROCKET EXPRESS

The Rocket Express high-speed oven is recommended for quickly finishing refrigerated, fresh, or frozen foods, like breakfast sandwiches, chicken wings, muffins, lasagnas, mac & cheese, sub sandwiches, and other partially prepared foods, yielding excellent flavor, appearance, and crisp results. The combination of impinged air, microwaves, and infrared radiation allows for heating, browning, or toasting foods faster than traditional methods. Ideal for larger portions. Its spacious interior provides ample room for cooking larger quantities of food, making it well-suited for situations requiring higher capacity.



EASY OPERATION

SKU: 990043



- User interface: full-color user-friendly touchscreen display. Drag and drop features.
- Stores unlimited recipes with up to 8 steps each, divided into 16 groups.
- USB port for system updates and importing/exporting groups, recipes, and settings.
- Wi-Fi capabilities, enabling remote management for system updates and importing/exporting groups, recipes, and settings via the IOK online platform.
- Adjustable temperature from 86°F (30°C) to 536°F (280°C).
- Independent control of impinged air (highspeed air blast), microwaves, and infrared radiation.
- Heat insulation: prevents the surrounding area from heating up and keeps the surface cool to the touch.
- Certified Ventless – no need for vent hoods.
- The removable catalytic converter allows operators to perform the cleaning without the need for a maintenance service call.
- Built-in fixed feet.
- Constructed from stainless steel.
- Additional functionalities: Test Mode and Favorites.
- Daily cleaning guide with explanatory videos displayed on the screen, demonstrating the step-by-step process.

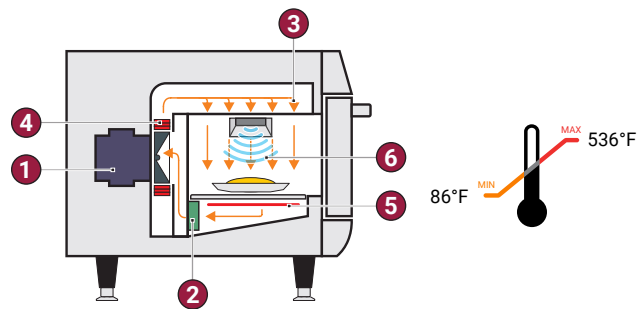

- 1. Blower Motor
- 2. Catalytic Converter
- 3. Impinged Air
- 4. Impingement Heater
- 5. IR Heater
- 6. Microwaves

### COOK TIMES

Roasted Brussels Sprouts	<b>2 min 30 sec</b>
French Bread	<b>1 min 30 sec</b>
8" toasted sub	<b>30 sec</b>
Chicken Wings	<b>3 min 30 sec</b>
Chicken Quesadilla	<b>1 min 15 sec</b>

CERTIFIED  
**VENTLESS**  
WITH EASILY REMOVABLE  
CATALYTIC CONVERTER.



LEARN MORE



WATCH THE VIDEO



CAD AND REVIT FILES



Aluminum Paddle



Speed Grill



Solid Basket



Cleaning Kit



USB Flash Drive

• **1 year warranty** for parts and labor, with the exception of naturally worn items.

Region	Voltage (V)	Phases	Freq. (Hz)	Power (kW)	Circuit Breaker (A)	Cable	Socket	Product dimensions (Height x Width x Depth)	Boxed product dimensions (Height x Width x Depth)	Chamber dimensions (Height x Width x Depth)	Clearance (Left / back / right side)
USA / Canada	208 240	Single	60	6.2 7.2	30	3x10 AWG	 NEMA 6-30	25x 20.9 x 31.7 (") <b>194 lbs.</b>	34 x 25.2 x 36.2 (") <b>250 lbs.</b>	5.7 x 15.5 x 14.2 (") <b>0.74 cu.ft</b>	0" / 0" / 0"

BACK TO MENU

# IOK

INTERNET OF KITCHEN

## PRÁTICA'S SMART HIGH-SPEED OVENS THE FUTURE OF COOKING

IOK is the connectivity solution for you to remotely manage, via Wi-Fi, recipes and data from your Prática Oven operation.



**MANAGE GROUPS  
AND RECIPES FROM  
YOUR COMPUTER**

Create, edit, remove, and distribute groups and recipes from the computer to all compatible ovens.



**CUSTOMIZE THE  
DISPLAY IMAGE OF  
RECIPES**

Illustrate recipes with real images of your products.



**RECEIVE SOFTWARE  
UPDATES**

Always count on system improvements for free, from small adjustments to major updates (such as a new interface or function, for example).

# PRÁTICA IOK USES YOUR WI-FI TO ALLOW FOR SEAMLESS MANAGEMENT OF EQUIPMENT ACROSS MULTIPLE LOCATIONS

Standardize your production and keep track of your ovens even when you are out of your kitchen.



All our touchscreen models now come with Wi-Fi capabilities and are connected to the IOK.



The IOK is 100% included with your oven purchase—no extra cost or monthly payments required.



When using the IOK it allows you to manage your equipment from anywhere, you can monitor and access IOK from anywhere, PC, MAC, mobile, or tablet.



Manage all your ovens and menus from one place.



Create, edit and organize groups, recipes, and complete menus directly on the oven or from your computer and send to all connected ovens.



Customize the recipe icons with photos of your own dishes.



The IOK helps with the consistency of your recipe programming which allows your menu and recipes to be consistent from start to finish.



Obtain the newest updates on your IOK features, interface, and display configuration directly to your machines- no matter the location



Access the exclusive Cookbook with complete recipe suggestions created by Prática's Chefs.



Get customer support via chat using the IOK platform.



Nothing  
cleans and  
protects like  
**Prática**



## CLEANING KIT BENEFITS

Specially formulated for Prática High-Speed Ovens

### OVEN CLEANER

- Non-caustic, non-corrosive, and non-flammable
- Dissolves heavy soils, carbonized buildup, fat, oil, and grease.
- Use it in commercial kitchens to save time and labor.
- Excellent cleaning and degreasing power.
- Safe for use on aluminum.

### OVEN PROTECTOR

- Prevents carbonized buildup, fat, oil, and grease from sticking to oven walls.
- It makes oven cleaning easier, saving time and labor.
- Use it in commercial kitchens to keep ovens looking like new.
- Blend of all GRAS ingredients (GRAS - Generally Recognized As Safe by the FDA).



CLEANING  
GUIDES

FIT EXPRESS



FIT XL



FIT ST



FORZA STI



ROCKET  
EXPRESS



BACK TO MENU

## SPEED OVENS ACCESSORIES

### Panini Press

**SKU:** 800552  
**Dimensions:** 11.8" x 11.9" x 2.4"  
**Compatibility:** Fit Express / Fit SM / Fit ST



### Ceramic Stone

**SKU:** 200102  
**Dimensions:** 12.5" x 14.5" x 0.38"  
**Compatibility:** Rocket Express



### Speed Grill

<b>SKU:</b> 800504	<b>800526</b>	<b>800558</b>
<b>Dimensions:</b> 13" x 14" x 0.25"	11" x 11" x 0.25"	16" x 16" x 1.38"
<b>Compatibility:</b> Rocket Express	Fit Express / Fit SM / Fit ST	Fit XL



### Solid Basket

<b>SKU:</b> 200201	<b>200205</b>	<b>200217</b>
<b>Dimensions:</b> 13.5" x 13.5" x 1"	11" x 11" x 1"	15" x 15" x 1"
<b>Compatibility:</b> Rocket Express	Fit Express / Fit SM / Fit ST	Fit XL

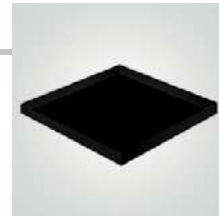

### Perforated Basket

<b>SKU:</b> 200202	<b>200211</b>	<b>200216</b>
<b>Dimensions:</b> 13.5" x 14.5" x 1"	11" x 11" x 1"	15" x 15" x 1"
<b>Compatibility:</b> Rocket Express	Fit Express / Fit SM / Fit ST	Fit XL



### Pizza Screen

<b>SKU:</b> 200602	<b>200609</b>
<b>Dimensions:</b> 14"	16"
<b>Compatibility:</b> Forza STi	Forza STi



### Wave Perforated Basket

**SKU:** 200210  
**Dimensions:** 10.125" x 10.125" x 1.75"  
**Compatibility:** Fit Express / FIT SM / FIT ST / FIT XL / Rocket Express



## Aluminum Paddle

<b>SKU:</b>	800163	800507	800560
<b>Dimensions:</b>	12" x 13.5"	10" x 19"	14.17" x 25"
<b>Compatibility:</b>	Rocket Express	Fit Express / Fit SM / Fit ST	Fit XL



## Aluminum Paddle Forza STi

<b>SKU:</b>	200607
<b>Dimensions:</b>	12" x 29.5"
<b>Compatibility:</b>	Forza STi



## Glass Cleaning Tool

<b>SKU:</b>	618213
<b>Dimensions:</b>	19" x 2"
<b>Compatibility:</b>	Forza STi



## Prática Oven Cleaner

<b>SKU:</b>	200902	200902-CS
<b>Dimensions:</b>	1 bottle	6 bottles per case
<b>Compatibility:</b>	Rocket Express / Fit Express / FIT SM / Fit ST / Fit XL / Forza STi	



## Prática Oven Protector

<b>SKU:</b>	200901	200901-CS
<b>Dimensions:</b>	1 bottle	6 bottles per case
<b>Compatibility:</b>	Rocket Express / Fit Express / FIT SM / Fit ST / Fit XL / Forza STi	



## Air Inlet Filter - Right Side

<b>SKU:</b>	753383
<b>Dimensions:</b>	Pack with 6
<b>Compatibility:</b>	Forza STi





## Catalytic Converter

**SKU:** 631712 | 760022  
**Compatibility:** Rocket Express | Forza STi



## Catalytic Converter

**SKU:** 634278  
**Compatibility:** Fit Express / Fit SM / Fit ST



## Oven Rack

**SKU:** 760200  
**Dimensions:** 15" x 10"  
**Compatibility:** Rocket Express



## Oven Rack

**SKU:** 753284  
**Dimensions:** 18" x 15"  
**Compatibility:** Forza STi



## Dual Trigger Sprayer

**SKU:** 200903  
**Compatibility:** Oven Cleaner and Oven Protector Bottles



## Cleaning kit

**SKU:** 200907

- 1 Dual Trigger Sprayer
- 1 Prática Oven Cleaner
- 1 Prática Oven Protector
- 1 Non-scratch Scrub Pad
- 2 Cleaning Towels





## WELCOME TO **PRÁTICA**

Prática, founded in 1991, offers cutting-edge equipment for the food preparation market, including an extensive product portfolio in the category of speed ovens. With over 700 employees, including 55 in Research & Development in its fully operational 250,000 sq ft factory located in Minas Gerais, Brazil, where it is the market leader. Additionally, the company has a strong presence in the international market, with branches in the United States and Chile, and exports its products to more than 50 countries.

At Prática, our purpose is to help our customers prepare high-quality food without waste. We understand the crucial role we play in the chain that begins with fields and crops and ends with providing prepared food to people. With our state-of-the-art technology and integrated product solutions, as well as pre-and post-sales support networks, we truly improve our customers' operations in quality food preparation, productivity, and profitability.

A well-aligned team, driven by strong values and a positive vision for the future, is propelling Prática towards an increasingly prominent position in the world.



# OUR VALUES

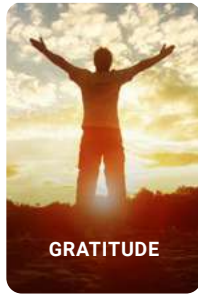
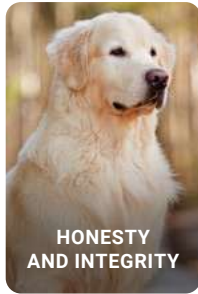
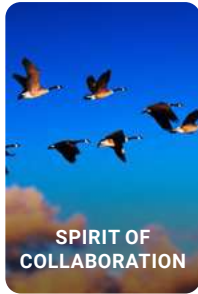
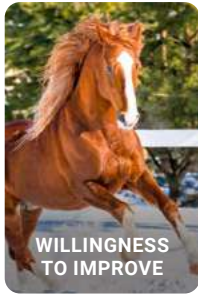

# OUR PURPOSE

## QUALITY FOOD WITHOUT WASTE



WELL-BEING



PRODUCTIVITY



SUSTAINABILITY



MANUFACTURING PLANT  
State of Minas Gerais - Brazil

# PRESENT IN OVER 50 COUNTRIES

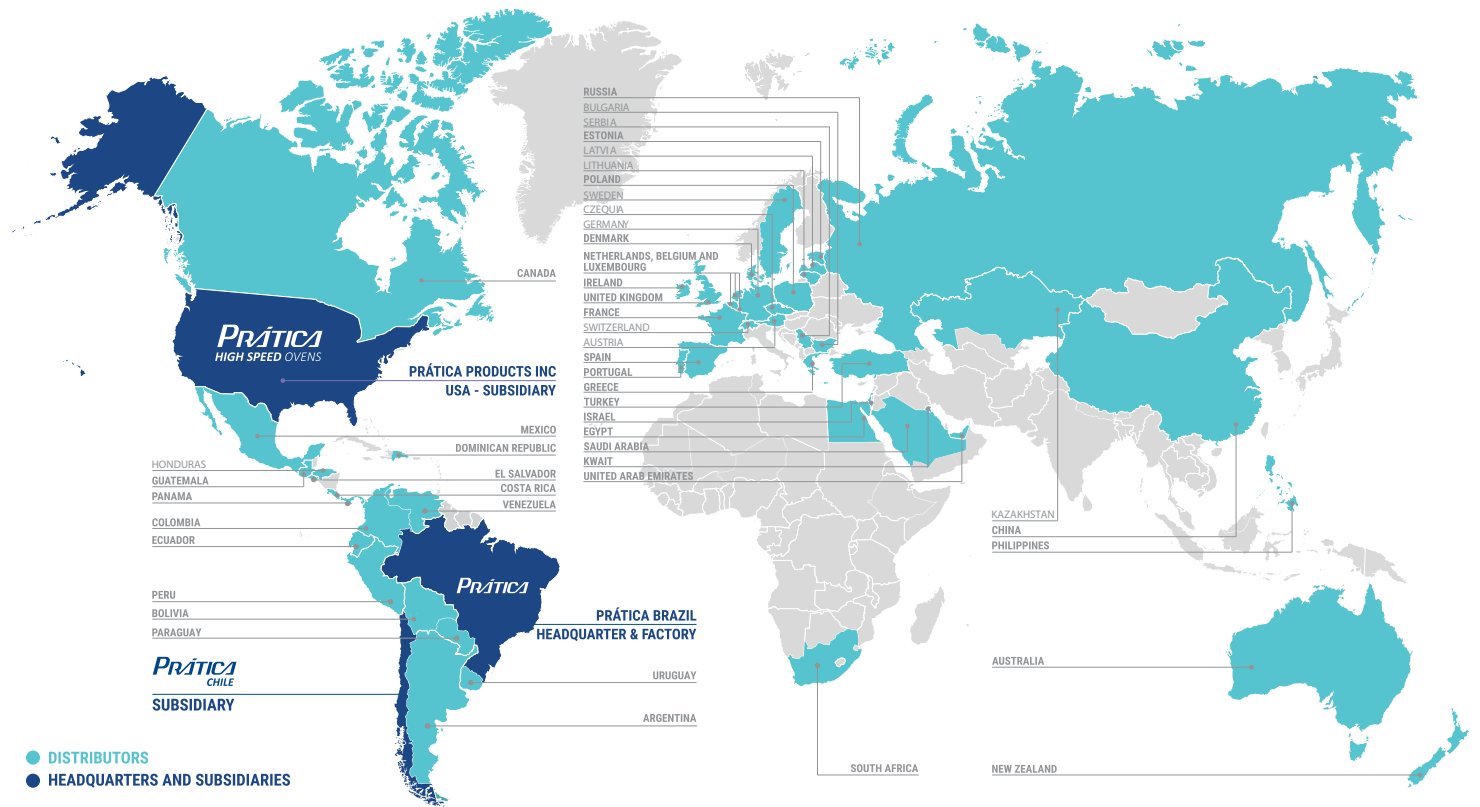

# COVERAGE FOR SALES AND SERVICE IN ALL **50** STATES

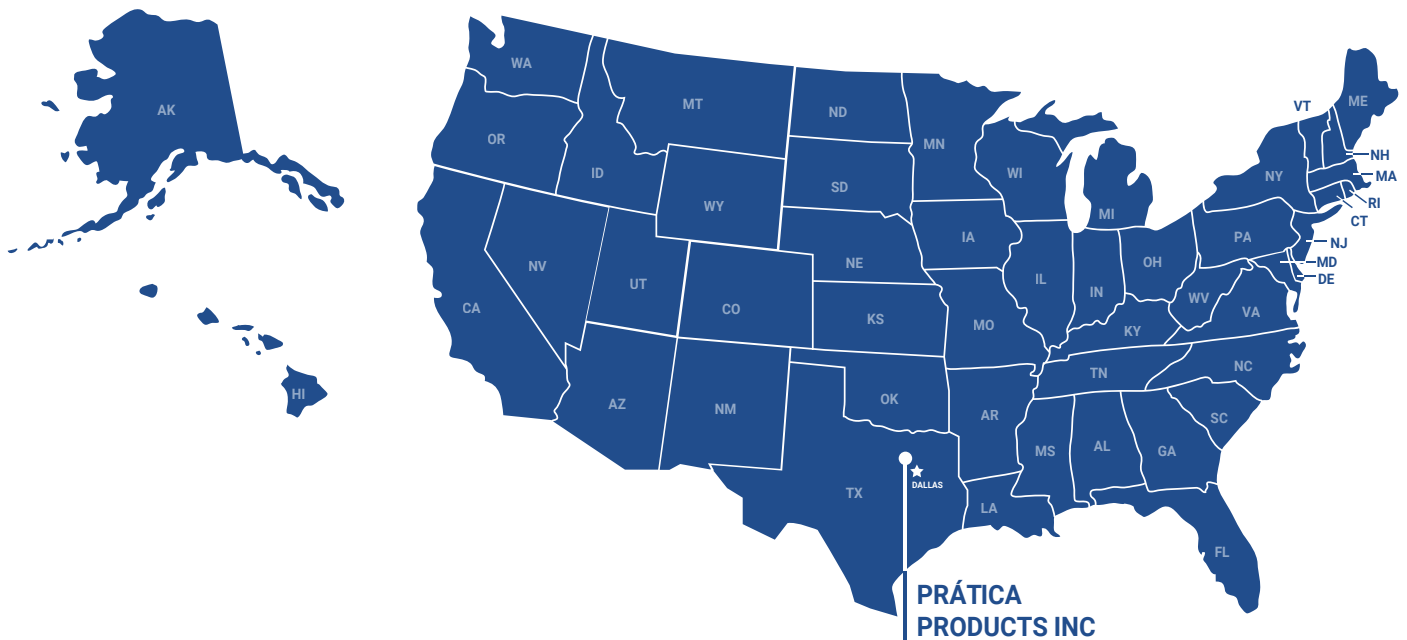

- \* Nationwide parts distribution - Partstown USA
- \* Nationwide Service Network - NSC
- \* Nationwide Sales coverage by independent sales representatives



## PRICE LIST



ACCESSORIES AND  
CONSUMABLES  
BUY ONLINE



## WARRANTY

Prática Products Inc. warranties all high-speed ovens for a period of one (1) year covering manufacturer defects, part failures, and pre-approved labor, and two (2) years on all the heating elements, magnetrons, and blower motor of the oven. The warranty period starts on the installation day.

The warranty excludes user abuse, ordinary wear, tear, and other conditions described in full in the product user's manual.



## FREIGHT AND SHIPPING

Prática Products Inc. provides the most economical ground transportation possible, consistent with guaranteed freight and minimal terminal switching. Any special request, as in residential delivery, lift gate, or phone appointment, will have an additional charge. Prática Products Inc. imposes no hidden mark-ups; all freight charges are passed through the customer at our cost.

Any missing product, loss, or damage in shipment must be reported to Prática Products Inc. and the delivery common carrier immediately on receipt of shipment, and noted on the delivery receipt.

Shipments should be inspected before accepting delivery; if any damage is noticed, shipment should be refused. Any concealed damage noticed within 2 days of accepting delivery should be reported by consignee to the common carrier. Freight claims are the responsibility of the cosigner.

*For information on terms and conditions  
please use the following QR code.*



## TERMS AND CONDITIONS

---

All prices are quoted in \$ U.S. dollars and are subject to change without notice. State sales tax will be added to the invoice if resale tax certificate is not on file.

Terms are net 30-days upon approved and established credit. Prices are quoted F.O.B from our warehouse in Lewisville, TX. Prática Products Inc. reserves the right to review, accept, or reject all purchase orders.

Purchase orders are only considered valid after written acknowledgement is received by the customer.

Prática Products Inc. reserves the right to change or modify the design, specification and substitute materials in construction of any product manufactured without notice.

All product dimensions are nominal and are subject to change.

## RETURN POLICY

---

Any missing product, loss, or damage in shipment must be reported to Prática Products Inc. and the delivery common carrier immediately on receipt of shipment, and noted on the delivery receipt.

Shipments should be inspected before accepting delivery; if any damage is noticed, shipment should be refused. Any concealed damage noticed within 2 days of accepting delivery should be reported by consignee to the common carrier. Freight claims are the responsibility of the cosigner.

Unless Prática agrees otherwise, specifically in writing, sales are final. Returns of products will not be accepted unless Prática has provided written authorization. Returns are subject to a 25% restocking fee of the total order.

# **Prática**

**HIGH SPEED OVENS**

Prática Products, Inc. - USA

911 E State Hwy 121 Business, #101 - Lewisville, TX 75057 – USA

[www.praticausa.com](http://www.praticausa.com)

 [praticausa](#)  [praticaus](#)  [praticausa](#)  [praticahighspeedovens](#)

 [Info@praticausa.com](mailto:Info@praticausa.com)  +1 214-584-6269