

## Fit XL Speed Oven

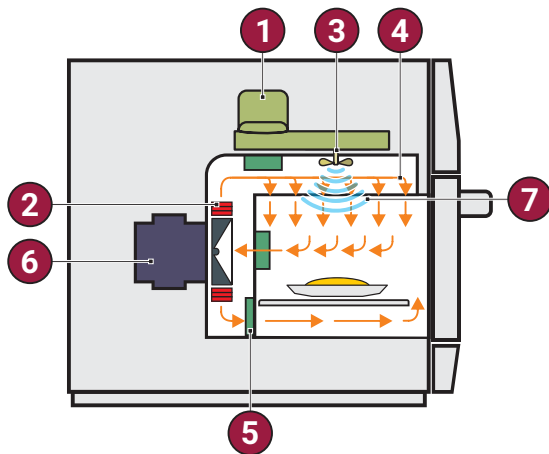

- 1 - Magnetron
- 2 - Impingement Heater
- 3 - Stirrer
- 4 - Impinged air
- 5 - Catalytic converter
- 6 - Blower motor
- 7 - Microwaves

### RECOMMENDATION

- The Fit XL high-speed oven is designed for efficiently finalizing refrigerated, fresh, or frozen foods, such as breakfast sandwiches, chicken wings, muffins, lasagnas, mac & cheese, sub sandwiches, and other partially prepared dishes. It delivers excellent flavor, appearance, and crispiness. The combination of impinged air and microwaves allows for heating, browning, or toasting foods faster than traditional methods.

### TECHNICAL FEATURES AND FUNCTIONALITIES

- Stores unlimited recipes with up to 8 steps each, divided into 16 groups.
- USB port for system updates and importing/exporting groups, recipes, and settings.
- Wi-Fi capabilities, enabling remote management for system updates and importing/exporting groups, recipes, and settings via the IOK online platform.
- Adjustable temperature from 86°F (30°C) to 536°F (280°C).
- Independent control of impinged air (high-speed air blast) and microwaves.
- User-friendly touchscreen panel.
- Constructed from stainless steel.
- Certified Ventless – no need for vent hoods. Easy-to-remove catalytic converter for hassle-free cleaning.
- Additional functionalities: Test Mode and Favorites.
- Daily cleaning guide with explanatory videos displayed on the screen, demonstrating the step-by-step process.
- Warranty: one (1) year covering manufacturer defects, part failures, and pre-approved labor, and two (2) years on all the heating elements, magnetrons, and blower motor of the oven.

### INCLUDED ACCESSORIES

- 01 - Aluminum Paddle;
- 01 - Solid Basket;
- 01 - Perforated Basket;
- 01 - USB Flash Drive;
- 01 - Cleaning kit (1 Dual Trigger Sprayer, 1 Prática Oven Cleaner, 1 Prática Oven Protector, 1 Non-scratch Scrub Pad, and 2 Cleaning Towels).

### AVAILABLE COLORS

- Black;
- Stainless Steel.



Black

Stainless Steel



**Intertek**

### PRODUCT DIMENSIONS

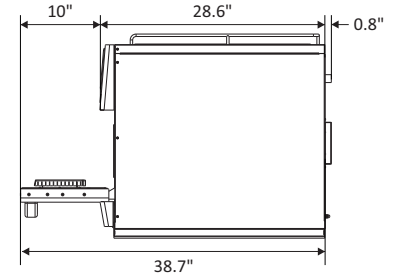
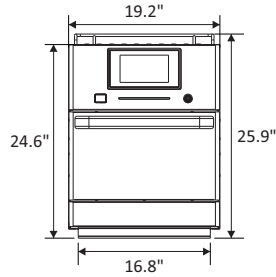
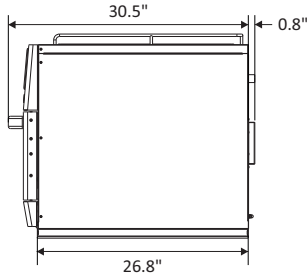

### INSTALLATION

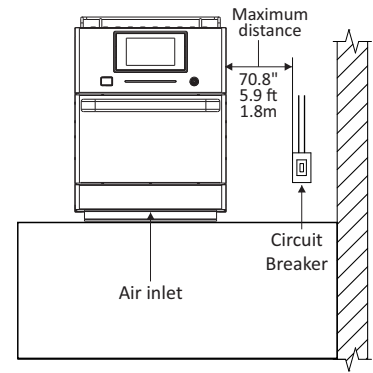
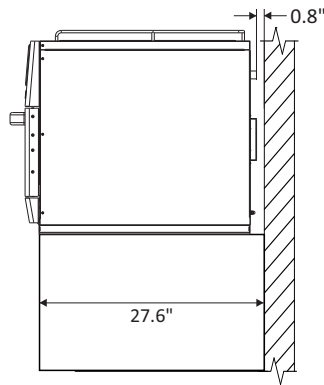
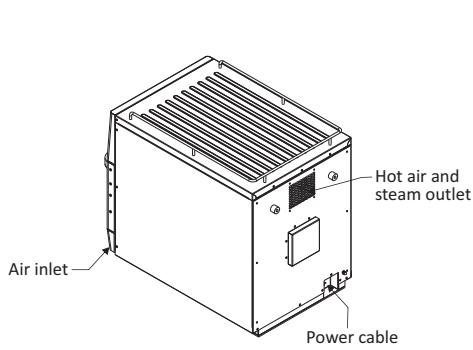

### ELECTRICAL SPECIFICATIONS

Ensure that the electrical configuration of the building is in accordance with the technical specifications located on the serial plate located on the back panel of the unit.

The outlet should be located no more than 70.8" / 5.9ft away from the unit.

This plug must be connected to a properly installed and grounded outlet.

In case of a short circuit, the unit's ground connection reduces the risk of electrical shock.

The customer is responsible for the electrical conditions at the installation site.

Region	Voltage (V)	Phases	Freq. (Hz)	Power (kW)	*Circuit Breaker (A)	Cable	Socket
USA	208	Single	60	6.2	30	3x10 AWG	NEMA 6-30
	240			7.0			
Canada	208	Single	60	6.2	30	3x10 AWG	NEMA 6-30
	240			7.0			

\*Prática recommends installing a type D circuit breaker whilst remaining in accordance with local regulations.

### GENERAL INSTRUCTIONS

The oven must be installed on a base or counter that supports the weight of the unit (approximately 180.7 lbs. / 82 kg). For proper ventilation, a minimum space of 0.8" is required between the back of the oven and the wall. The bumper, located at the back of the oven, has been designed to provide this necessary space at the back of the oven and cannot be removed.

Do not block the air inlets and outlets located on the front and back of the oven.

It is not recommended for the unit to be positioned near stoves, deep fryers, hot plates and other equipment that releases fat, fumes and heat.

The oven must be installed at a leveled and ventilated location.

Improper installation may void the equipment warranty.

### DIMENSIONS

Fit XL	Product dimensions				Boxed product dimensions			
	Height	Width	Depth	Weight	Height	Width	Depth	Weight
	25.9"	19.2"	31.3"	180.8lbs 82kg	35.6"	23.2"	37.8"	227lbs 103kg
Chamber dimensions	Capacity		Height	Width	Depth			
	0.83 cu.ft 23.7L		5.5"	16.4"		16.1"		
Clearance	Left side		Back	Right side				
	0"		0"	0"				